

G-Series Analog or Start/Stop

Temposonics® GP and GH
Stroke length 50...7600 mm
depends on output

Document Part Number
551383 Revision C



- Rugged industrial sensor
- Linear absolute measurement
- Contactless sensing with highest durability
- Enhanced diagnostics and programming capability
- EMC tested and marked with CE
- Superior accuracy: linearity less than 0.02 % F.S.
- Repeatability less than 0.001 % F.S.
- Direct analog output
- Digital start/stop pulse output

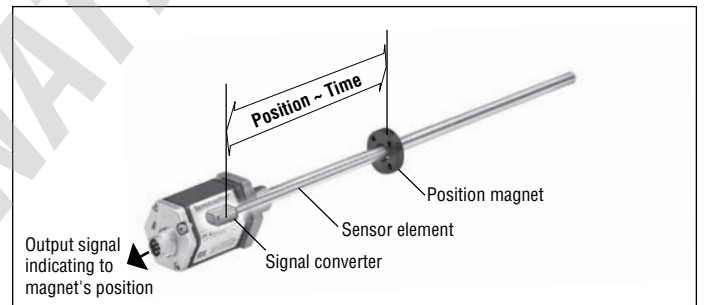

Magnetostriction

The Temposonics® linear position transducers are based on magnetostriction technology. Magnetostriction is a ferromagnetic material phenomenon which relates a dimensional change of the material to its magnetization properties. It is the product of a general coupling between the magnetic and elastic transport properties of the materials crystal lattice. This affect is typically on the scale of a few parts per million. It is quasi linear with the material's magnetization, may be positive or negative, and reaches a maximum at magnetic saturation. It is reversible, but exhibits a hysteretic affect if the magnetization does so. Magnetostriction was characterized in the late 19th century, the longitudinal version is called the „Joule“ effect, the torsional version is called the „Wiedemann“ effect, and the reciprocal effect where mechanical stress changes the magnetic properties is referred to as the „Villari“ effect.

Design

The extremely robust sensor, ideal for continuous operation under harshest industrial conditions is completely modular in mechanic and electronic design.

- A profile or rod-shaped sensor housing protects the sensing element in which gives rise to the measurement signal.
- The sensor head accommodates the complete modular electronic interface with active signal conditioning. Double encapsulation ensures high operating safety and optimum EMC protection.
- The position transmitter, a permanent magnet - fixed at the mobile machine part - drives contactlessly over the sensor's stroke and starts measuring through the housing wall.

Technical data

Input

Measuring variables	position, liquid level
Stroke length	
- Analog	profile/rod models: 50...2500 mm (longer stroke lengths are available on a custom basis)
- Start/Stop	profile model: 50...5000 mm, rod model: 50...7600 mm

Output

Voltage	0...10 / 10...0 / -10...+10 / +10...-10 VDC (min. load controller: > 5 kOhms)
Current	4(0)...20 mA / 20...4(0) mA (min/max. load: 0/500 Ohms)
Start/Stop pulse	RS422 serial differential signal

Accuracy

Position measurement:	
- Null/Span adjustment	100 % of electrical stroke (min. range 50 mm)
- Resolution	analog: infinite digital (start/stop): 0.1 mm; 0.01; 0.005 mm (controller dependent)
- Linearity ¹	< ± 0.02 % F.S. (minimum ± 50 µm)
- Repeatability	< ± 0.001 % F.S. (minimum ± 2.5 µm)
- Hysteresis	< 4 µm
- Update time	analog: < 1 ms typical digital (start/stop): controller and stroke dependent
- Ripple	< 0.01 % F.S.

Operating conditions

Magnet speed	any
Operating temperature	-40 °C...+80 °C
Dew point, humidity	90% rel. humidity, no condensation
Ingress protection ²	profile: IP 65, rod: IP 67, IP 68 for cable outlet
Shock test	100 g single hit, IEC-Standard 60068-2-27
Vibration test	15 g / 10...2000 Hz, IEC-Standard 60068-2-6 (resonance frequencies excluded)
EMC test	Electromagnetic emission EN 61000-6-4 (for use in industrial environment) Electromagnetic immunity EN 61000-6-2 The sensor meets the requirements of the EC directives and is marked with CE

Design, material

Diagnostic display	LEDs beside connector
<u>Profile model:</u>	
Sensor head	aluminum
Sensor stroke	aluminum
Position magnet	magnet slider or removable U-magnet
<u>Rod model:</u>	
Sensor head	aluminum
Rod with flange	stainless steel 1.4301 / AISI 304
-Pressure rating	350 bar, 700 bar peak
Position magnet	Ring magnets, U-magnets

Installation

Mounting position	any orientation
Profile	movable mounting clamps or T-slot nuts in base channel
Rod	threaded flange M18 x 1,5 or 3/4" -16 UNF-3A, hex nut M18
Position magnet	mounting plate and screws from antimagnetic material

Electrical connection

Connection type	6 pin connector
Supply voltage	24 VDC (-15 / +20 %); UL Recognition requires an approved power supply with energy limitation (UL 61010-1), or Class 2 rating according to the National Electrical Code (USA) / Canadian Electrical Code.
- Polarity protection	up to -30 VDC
- Overvoltage protection	up to 36 VDC
Current drain	100 mA typical
Ripple	≤ 0.28 Vpp
Electric strength	500 VDC (DC ground to machine ground)

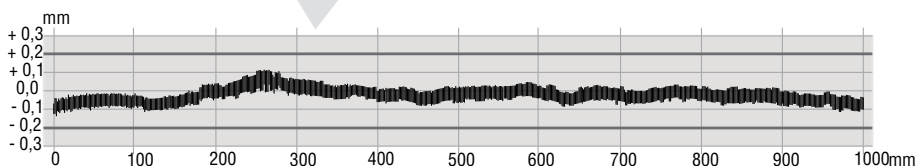

Linearity protocol example

Sensor Temposonics® GP/GH
Stroke length 1000 mm
Tolerance allowed: ± 0.2 mm
Tolerance measured: typical ± 0.09 mm

¹ with position magnet # 251 416-2.

² The IP rating is not part of the UL recognition

Temposonics® GP – Stable profile design

Temposonics® GP offers modular construction, flexible mounting configurations and easy installation. Position measurement is contactless via two versions of permanent magnets.

- A sliding magnet running in profile housing rails. Connection with the mobile machine part is via a ball jointed arm to taking up axial forces.
- A floating magnet, mounted directly on the moving machine part, travels over the profile at a low distance. Its air-gap allows the correction of small misalignments at installation.

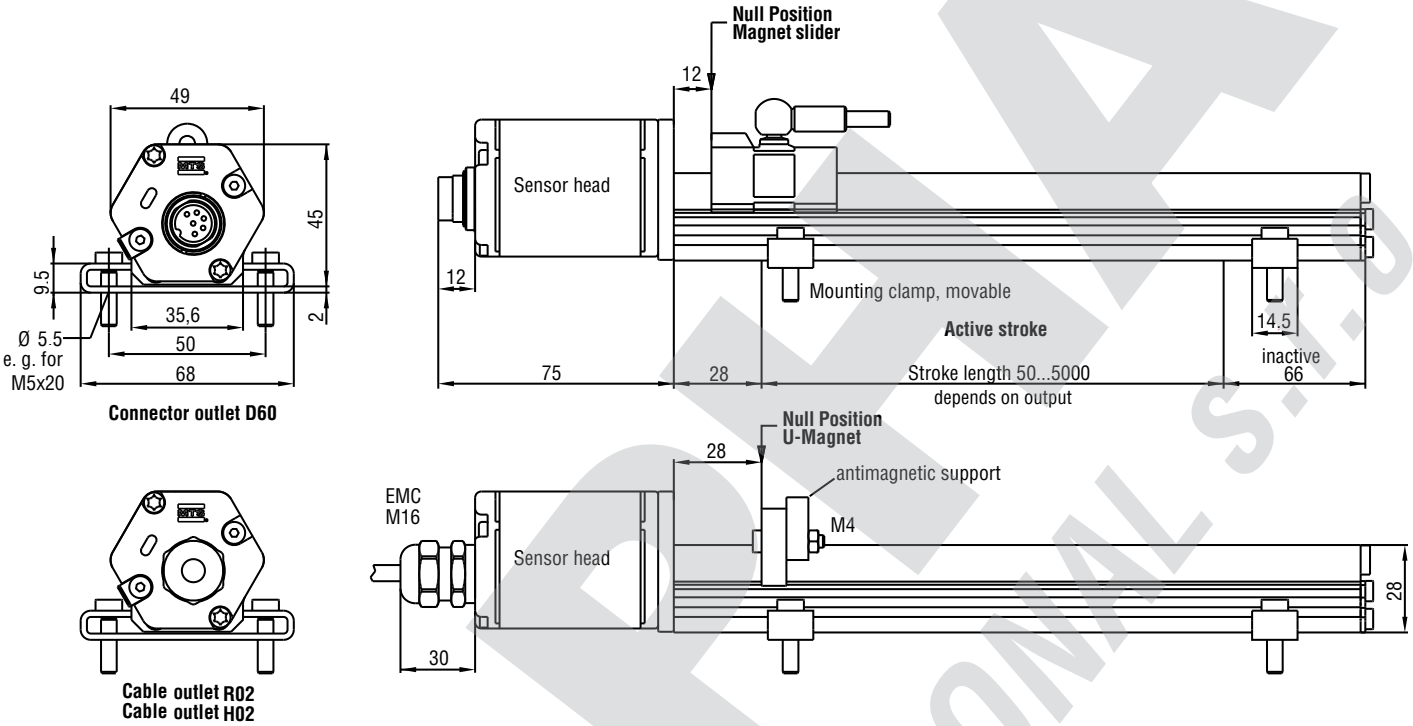

Position magnets (not included in delivery, please order separately)

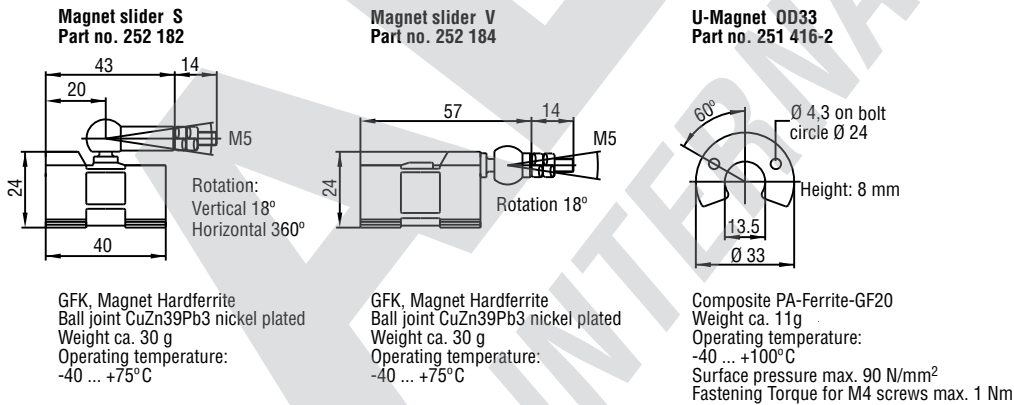

Other position magnets on request.

All dimensions in mm

Temposonics® GP/GH

Analog or Start/Stop

Temposonics® – High pressure rod design

Temposonics® GH with a pressure-resistant stainless steel flange and sensing rod is suitable for use in hydraulic cylinders and externally in all applications where space is a problem. Position measurement is done via ring or U-magnets travelling along the sensing rod without any mechanical contact.

Advantage...

the completely operable sensor cartridge can be replaced for servicing easily without opening the fluid circuit.

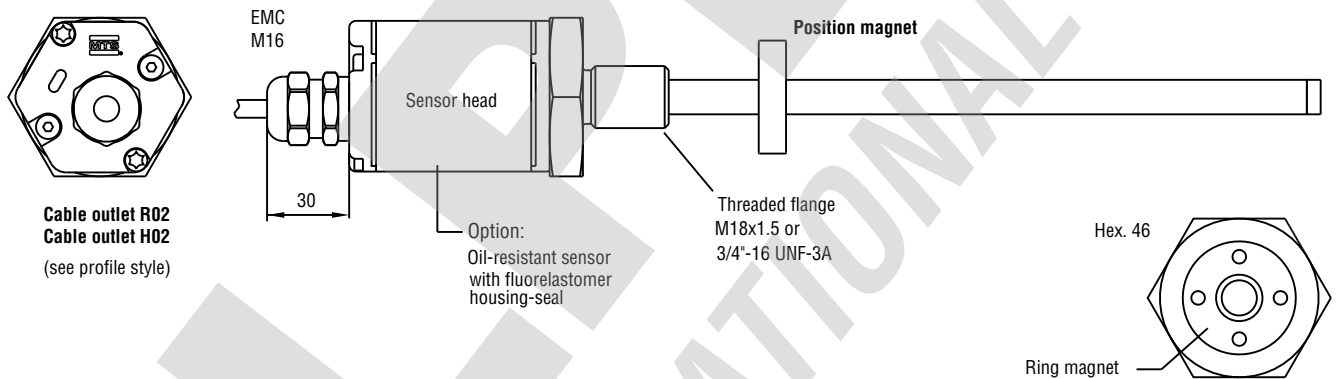
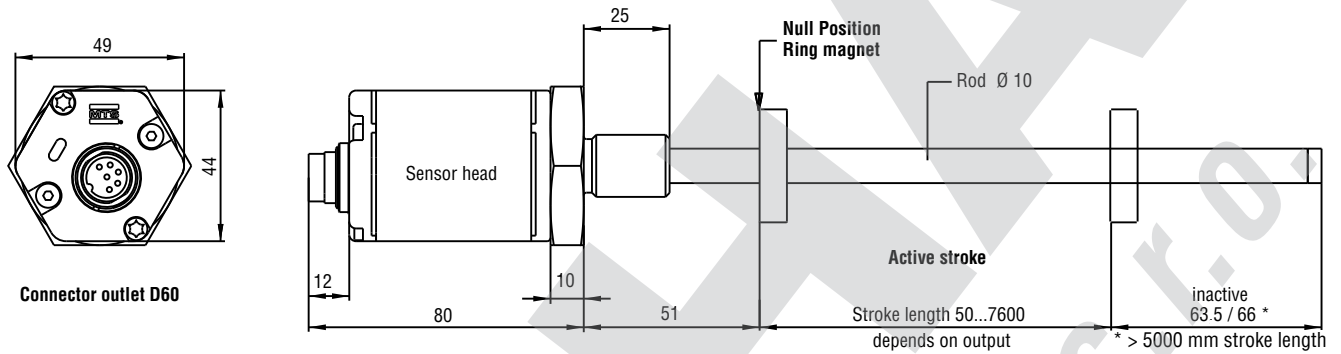

Position magnets (not included in delivery, please order separately)

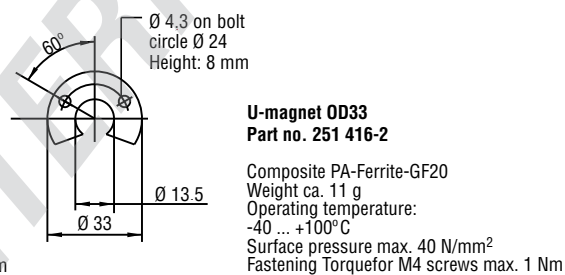
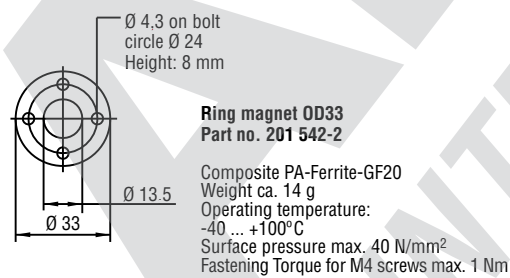

Other position magnets on request.

All dimensions in mm

Temposonics® G-Series – The next sensor generation

MTS Sensors is proud to introduce our new G-Series linear position sensors utilizing our next generation technology platform. G-Series sensors feature a microprocessor-based design with enhanced diagnostics and programmability to maximize backwards compatibility.

Sensor diagnostic display

Integrated LEDs (green/red) provide basic visual feedback for normal sensor operation and troubleshooting.



Green	Red	Description
ON	OFF	Normal function
ON	Flashing	Missing external start signal
ON	ON	Magnet not detected
Flashing	OFF	Serial programming mode

Connector wiring

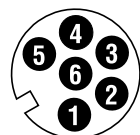

Male insert connector rear of cable connector

Pin	Cable	Analog	Digital
Pin 1	GY	V/mA	Stop (-)
Pin 2	PK	DC ground	Stop (+)
Pin 3	YE	USB-programmer	Start (+)
Pin 4	GN	USB-programmer	Start (-)
Pin 5	BN	+24 VDC (-15/+20 %)	
Pin 6	WH	DC ground	

Connectors (not included in delivery, please order separately)

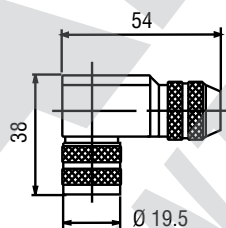
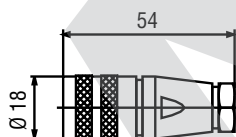

6 pin female connector M16, PG9 Part no.: 370 423

Housing: zinc, nickel-plated
Termination: solder
Contact insert: silver plated
Max. cable-Ø: 6...8 mm

6 pin 90° female connector M16 insert adjustable in 45° positions Part no.: 370 460

Housing: zinc, nickel-plated
Termination: solder
Contact insert: silver plated
Max. cable Ø: 6...8 mm

Analog output

Temposonics® G-Series with analog outputs provide direct analog outputs including voltage and current, forward or reverse acting. All outputs allow full adjustment of Null and Span setpoints (minimum range 50 mm between setpoints) inside the active electrical stroke length. Since the outputs are direct, no signal conditioning electronics are needed when interfacing with controllers or meters.

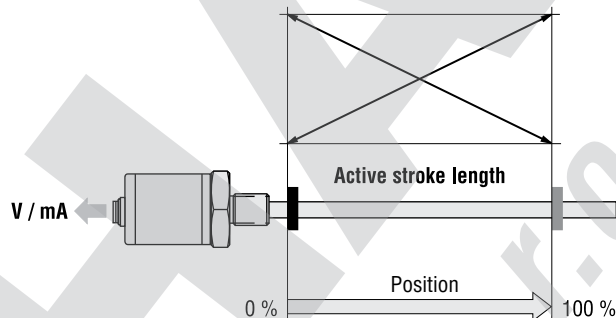

Start/Stop pulse output

The digital Temposonics® G-Series is equipped with a start/stop output. The sensor requires a start signal from an external indicator in the control system and returns a stop signal corresponding to the magnet's position. The time elapsed between the two signals is proportional to the position. Time measurement is done by the control unit and used for calculating the position value.

Option multi-magnet measurement: One Sensor can detect the positions of several magnets simultaneously.

Logic diagram

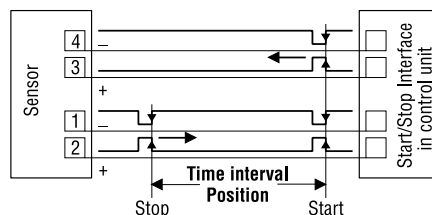
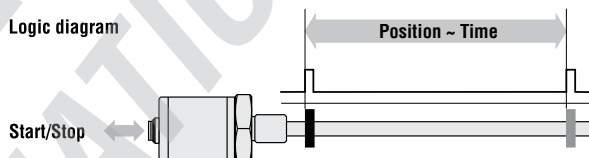

Flexible installation in any position

Profile model

Normally, the sensor is firmly installed - fixed on a straight surface of the machine with movable mounting clamps or M5 screws in base channel - whilst the magnet is mounted at the mobile machine part.

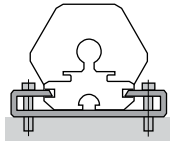

Mounting clamp with screws M5x20
Tightening torque: max. 5 Nm

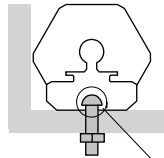

T-slot Nut in base channel

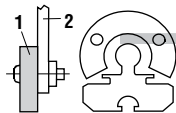
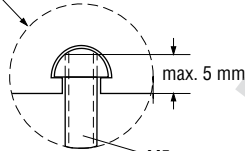

Do not exceed max. gap of 3 mm (± 1)

- 1 U-Magnet
- 2 Mounting plate and screws non-ferrous material

Rod model

Mount the sensor via flange thread or a hex nut. If possible, non-magnetizable material should be used for mounting support (dimensions as shown). With horizontal mounting, longer sensors (from 1 meter) must be provided with mechanical support.

Hydraulic sealing

Recommended is sealing of the flange facing with O-Ring (e.g. 22,4 x 2,65) in a cylinder cover nut or an O-Ring 15,3 x 2,2 in undercut.

Minimum assembly distance

1. Non-magnetizable material

2. Magnetizable material

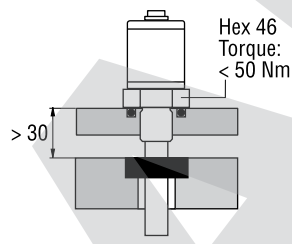

Recommended hydraulic sealing

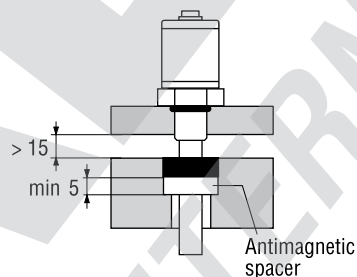

On delivery:
O-Ring 15,3 x 2,2
See ISO 6149-1

Cylinder installation

When used for direct stroke measurement in fluid cylinders, the sensor's high pressure, stainless steel rod should be installed into a bore in the piston head/rod assembly as illustrated. That guarantees a longlife and trouble-free operation - independent from the used hydraulic fluid.

The sensor cartridge can be removed from the flange and rod housing while still installed in the cylinder. This procedure allows quick and easy sensor cartridge replacement, without the loss of hydraulic pressure.

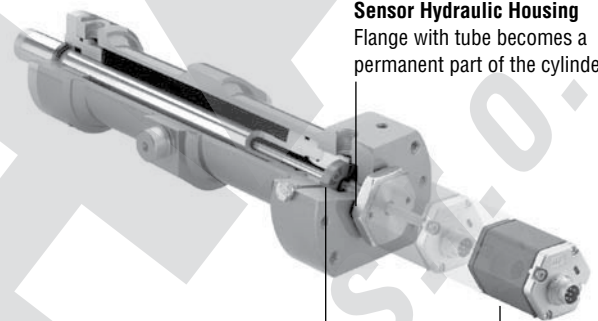

Sensor Hydraulic Housing

Flange with tube becomes a permanent part of the cylinder

Ring magnet

Sensor Cartridge

Electronic head + sensor element, easy to replace in field with two screws M4 (2.5 mm hexagon socket) Fastening torque $\leq 1.3 \text{ Nm}$

A liquid level sensor

With installation of the position magnet into a float, the application range of G-series extends substantially. These highly precise float sensors supply exact level values or - provided with suitable floats - interface heights e.g. in the process-industry or laboratory technology etc.

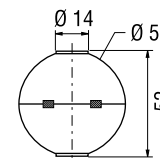
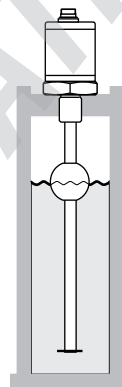

Magnet float (upon request)

Part no. 251 447

- Density 720 kg/m³
- Material 1.4571 polished AISI 316 Ti
- Pressure <math>< 25 \text{ bar}</math>

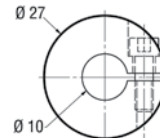

Collar

Part no. 560 777

ALPHA INTERNATIONAL S.r.o.

Document Part Number: 551383 Revision C (EN) 06/2014

MTS and Temposonics® are registered trademarks of MTS Systems Corporation. All other trademarks are the property of their respective owners. Printed in Germany.
Copyright © 2014 MTS Sensor Technologie GmbH & Co. KG. Alterations reserved. All rights reserved in all media. No license of any intellectual property rights is granted. The information is subject to change without notice and replaces all data sheets previously supplied. The availability of components on the market is subject to considerable fluctuation and to accelerated technical progress. Therefore we reserve the right to alter certain components of our products depending on their availability. In the event that product approbations or other circumstances related to your application do not allow a change in components, a continuous supply with unaltered components must be agreed by specific contract.



**MTS Sensor Technologie GmbH
& Co. KG**
Auf dem Schüffel 9
58513 Lüdenscheid, Germany
Tel. + 49-23 51-95 87 0
Fax + 49-23 51-5 64 91
E-Mail: info.de@mtssensors.com
www.mtssensors.com

MTS Systems Corporation
Sensors Division
3001 Sheldon Drive
Cary, N.C. 27513, USA
Tel. + 1-919-677-0100
Fax + 1-919-677-0200
E-Mail: info.us@mtssensors.com
www.mtssensors.com

MTS Sensors Technology Corp.
737 Aihara-cho,
Machida-shi, Japan
Tel. + 81-42-775-3838
Fax + 81-42-775-5516
E-Mail: info.jp@mtssensors.com
www.mtssensors.com